

K12 Integrated Mobile Sound System

SERVICE MANUAL

K12 SERVICE MANUAL

CONTENTS

	PAGE
PANEL LAYOUT	3
BLOCK	4
POWER	5
WAMP	6
ST TRN 1_2	7
PHONES & ZONE 2.....	8
MONO OUT.....	9
MAIN	10
LIMIT	11
GEQ.....	12
GEN POINT.....	13
EFFECT.....	14
2T	15
CH 1	16
CH 2	17
CH 3	18
CH 4	19
CH 5	20
CH 6	21
CH 7	22
CH 8	23
CH 9_10	24
 BOM	
POWER REQUIREMENT CLASSIFICATION	25
INPUT PCB	26
REAT PCB	30
AMP PCB.....	31
POWER PCB	34
DSP PCB.....	37
MISCELLANEOUS	38

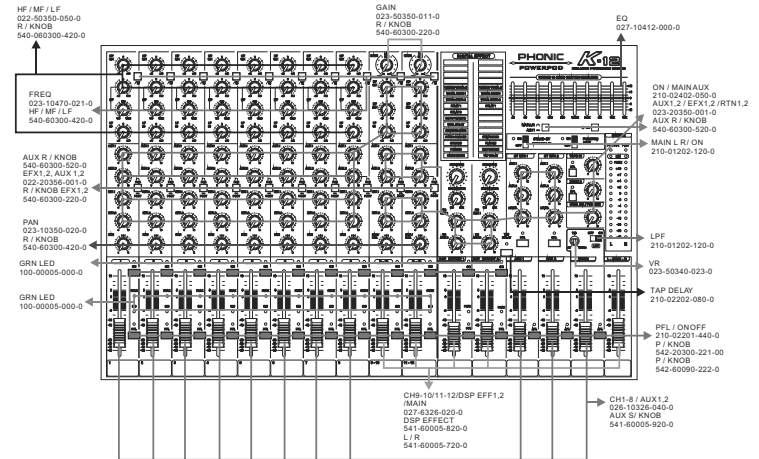
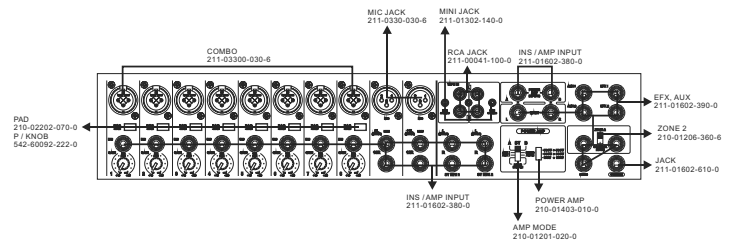
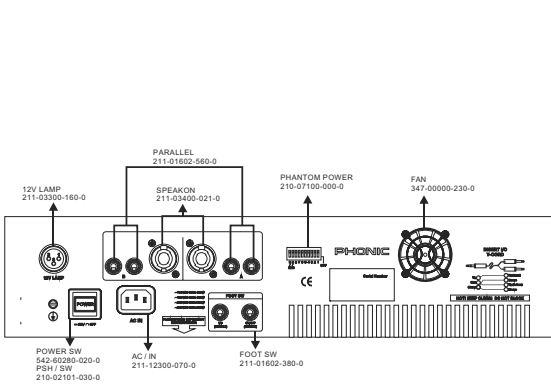

BLOCK

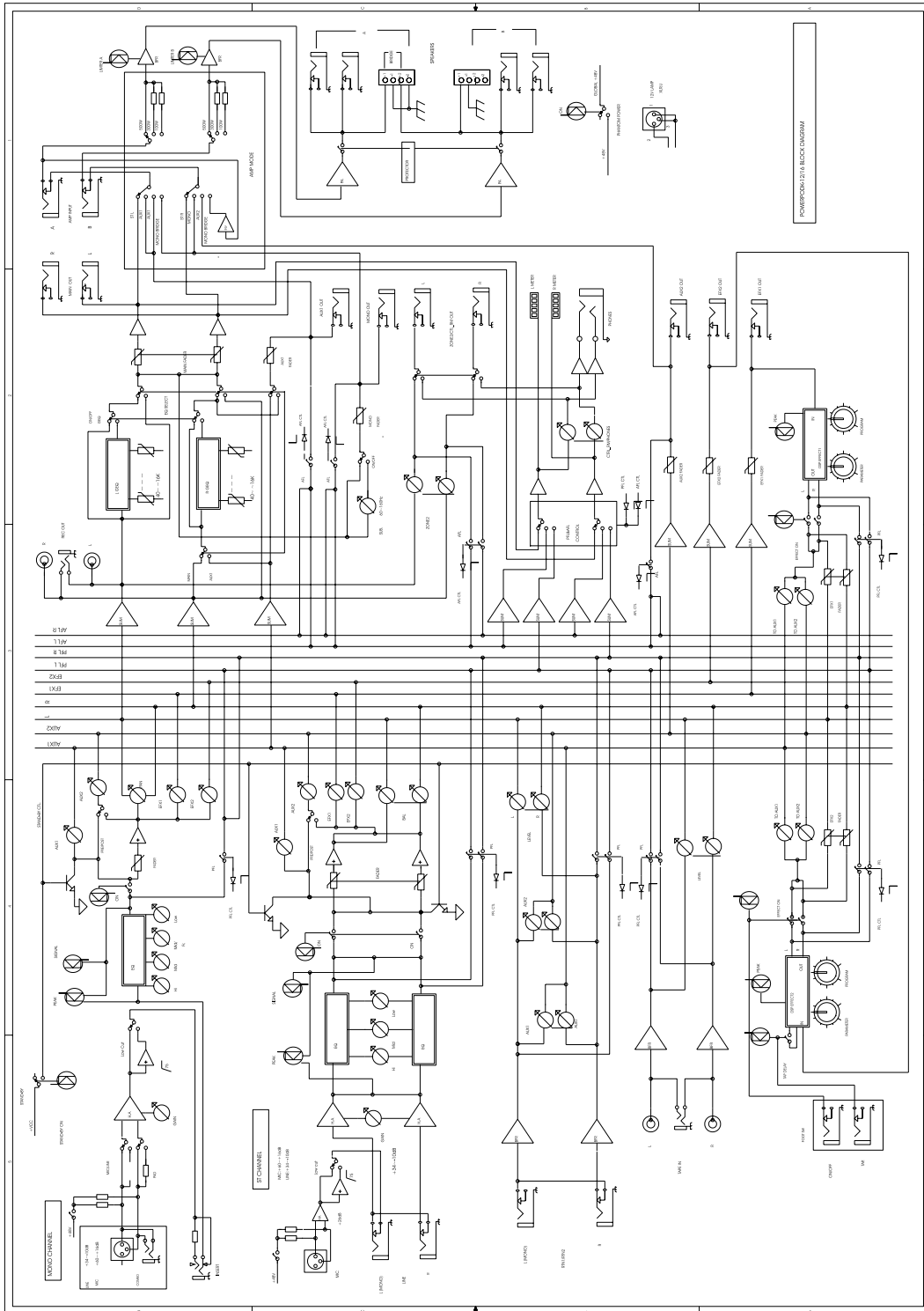

POWER

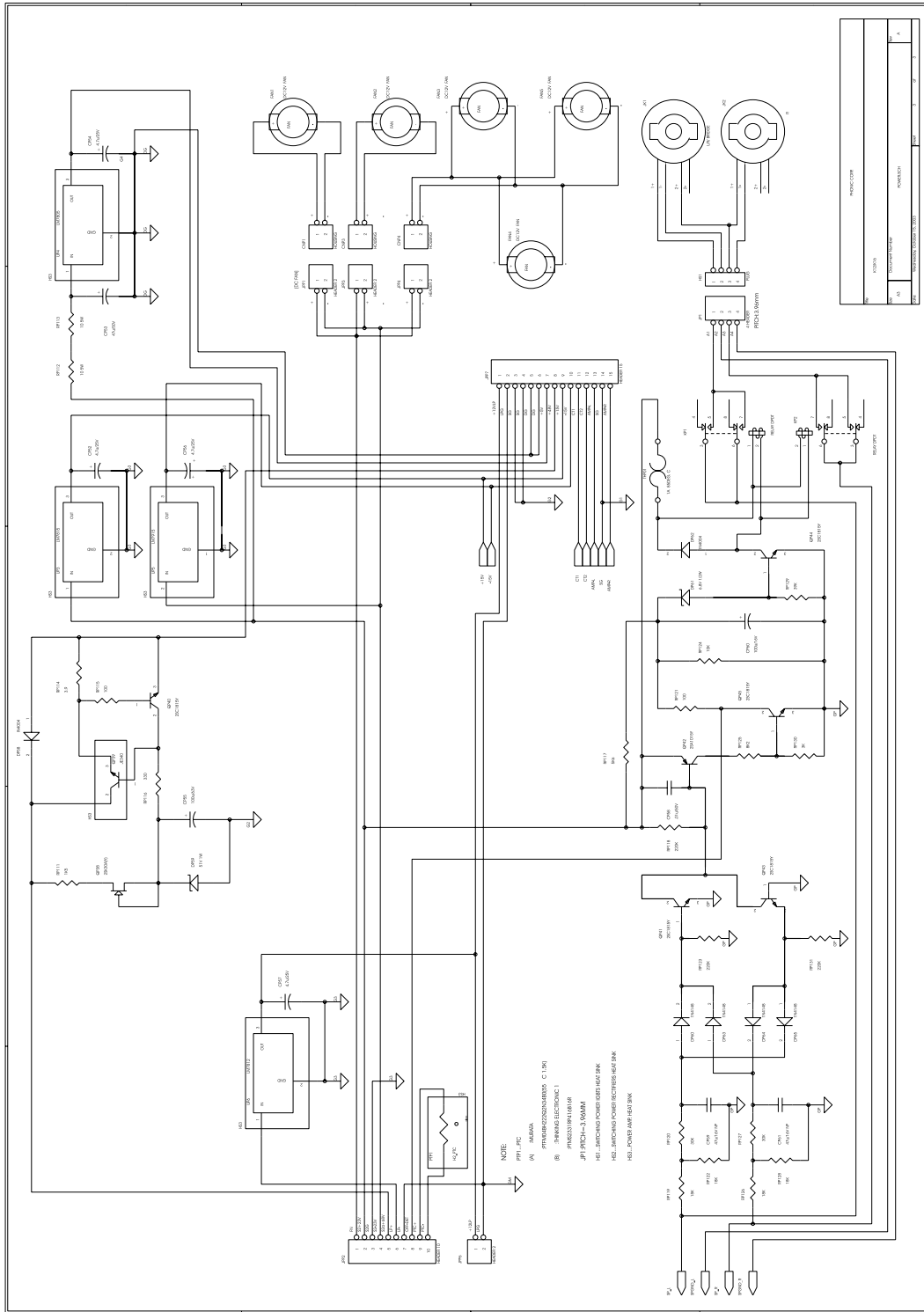

WAMP

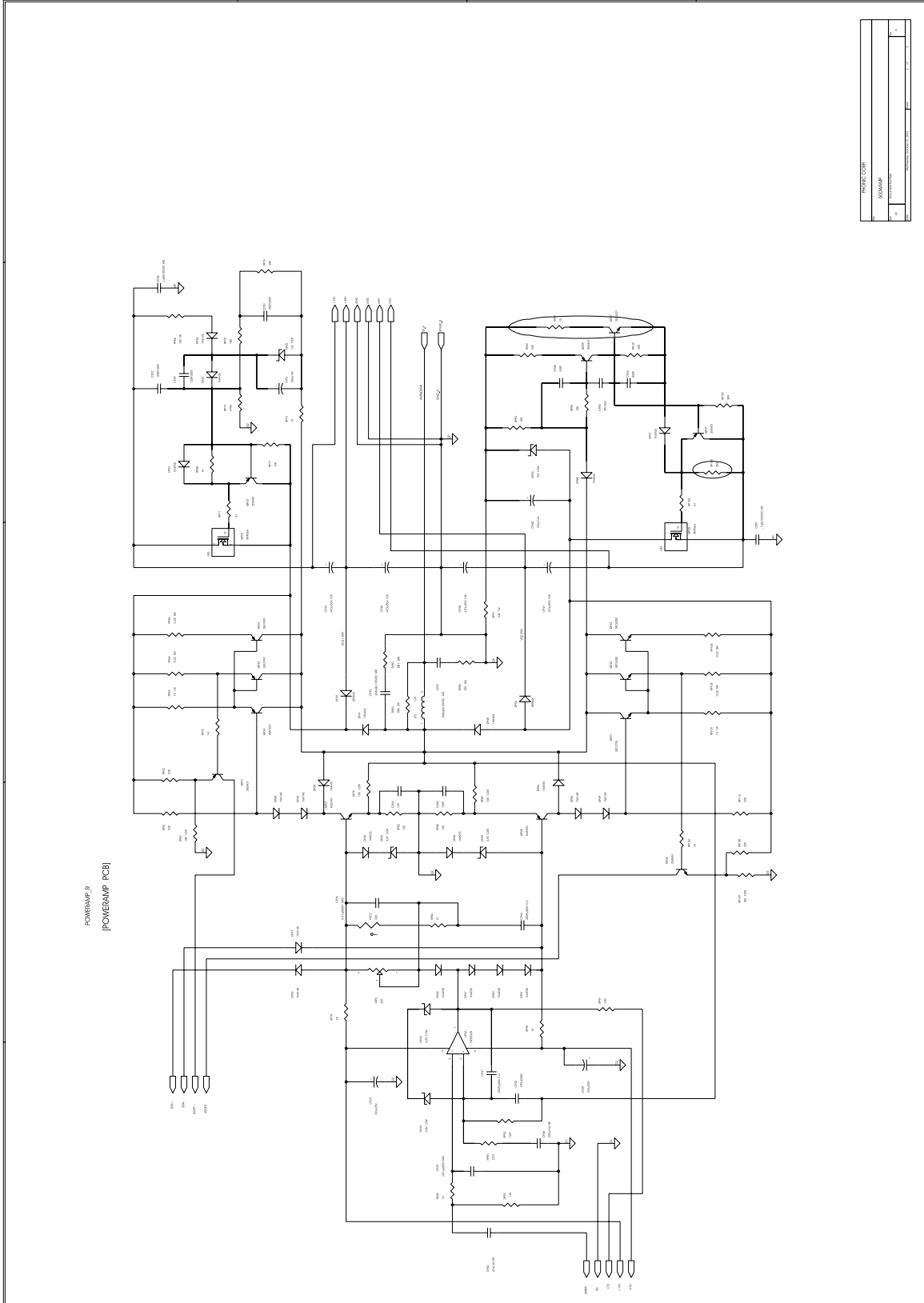

ST TRN 1_2

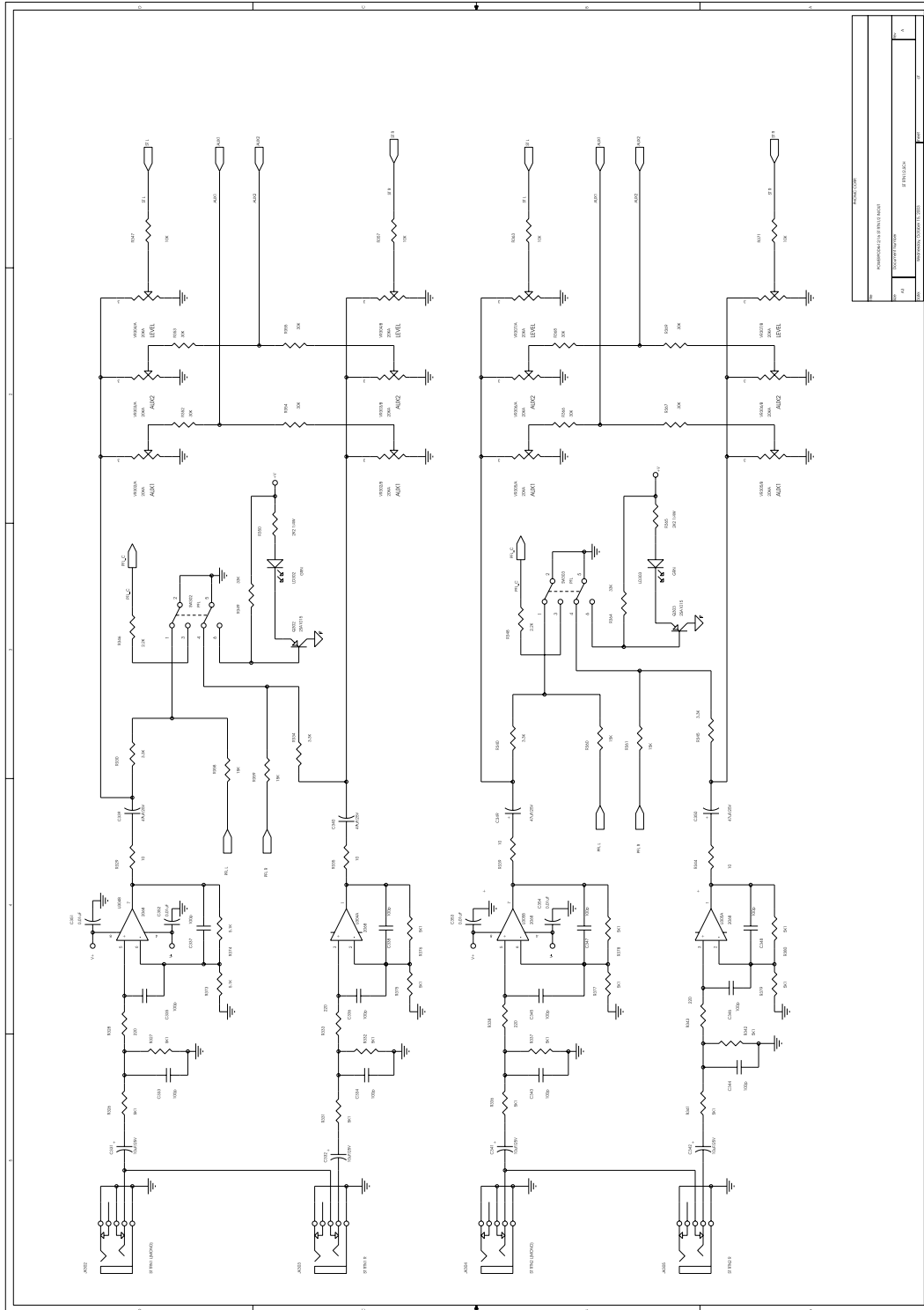

PHONES & ZONE 2

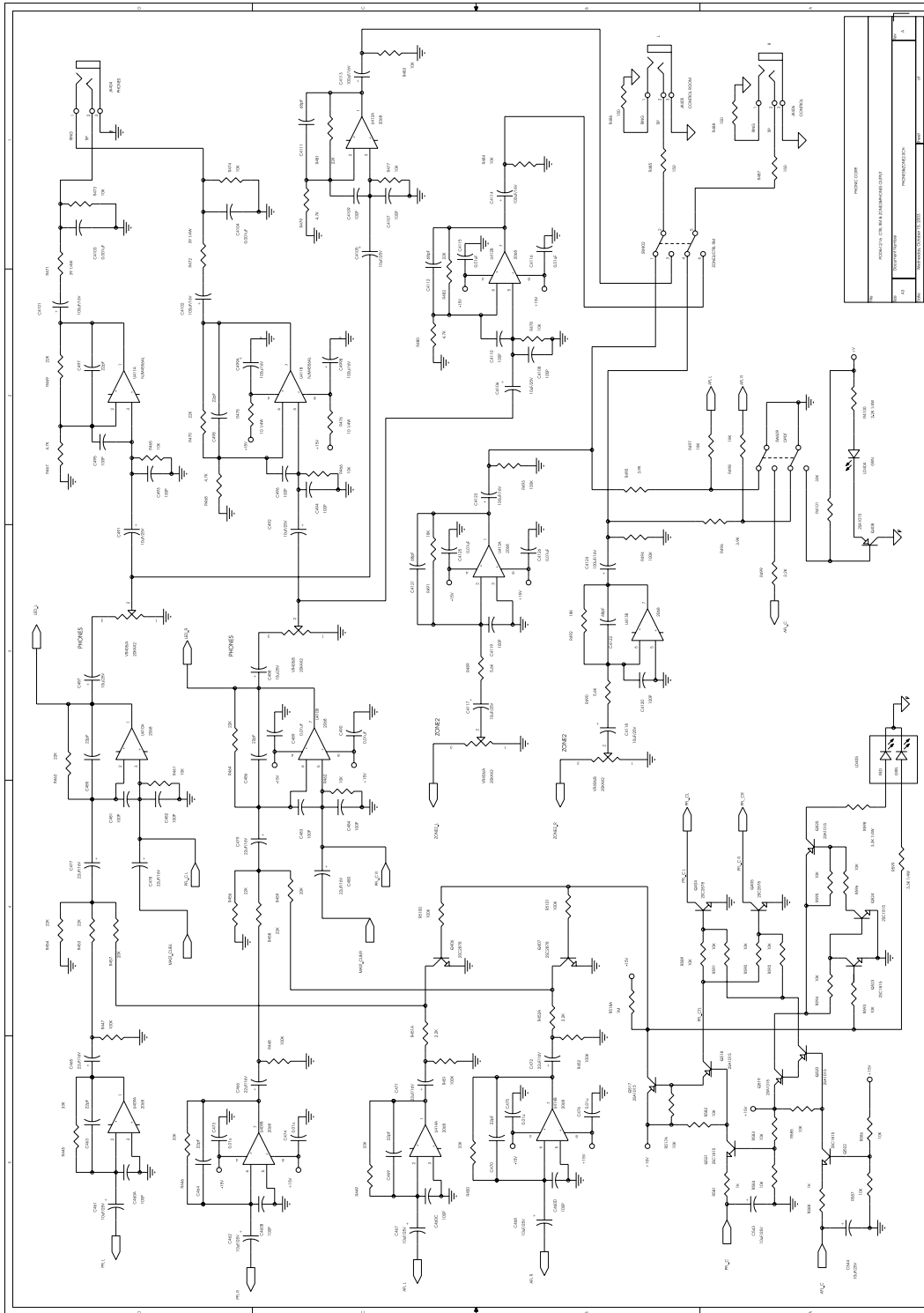

MONO OUT

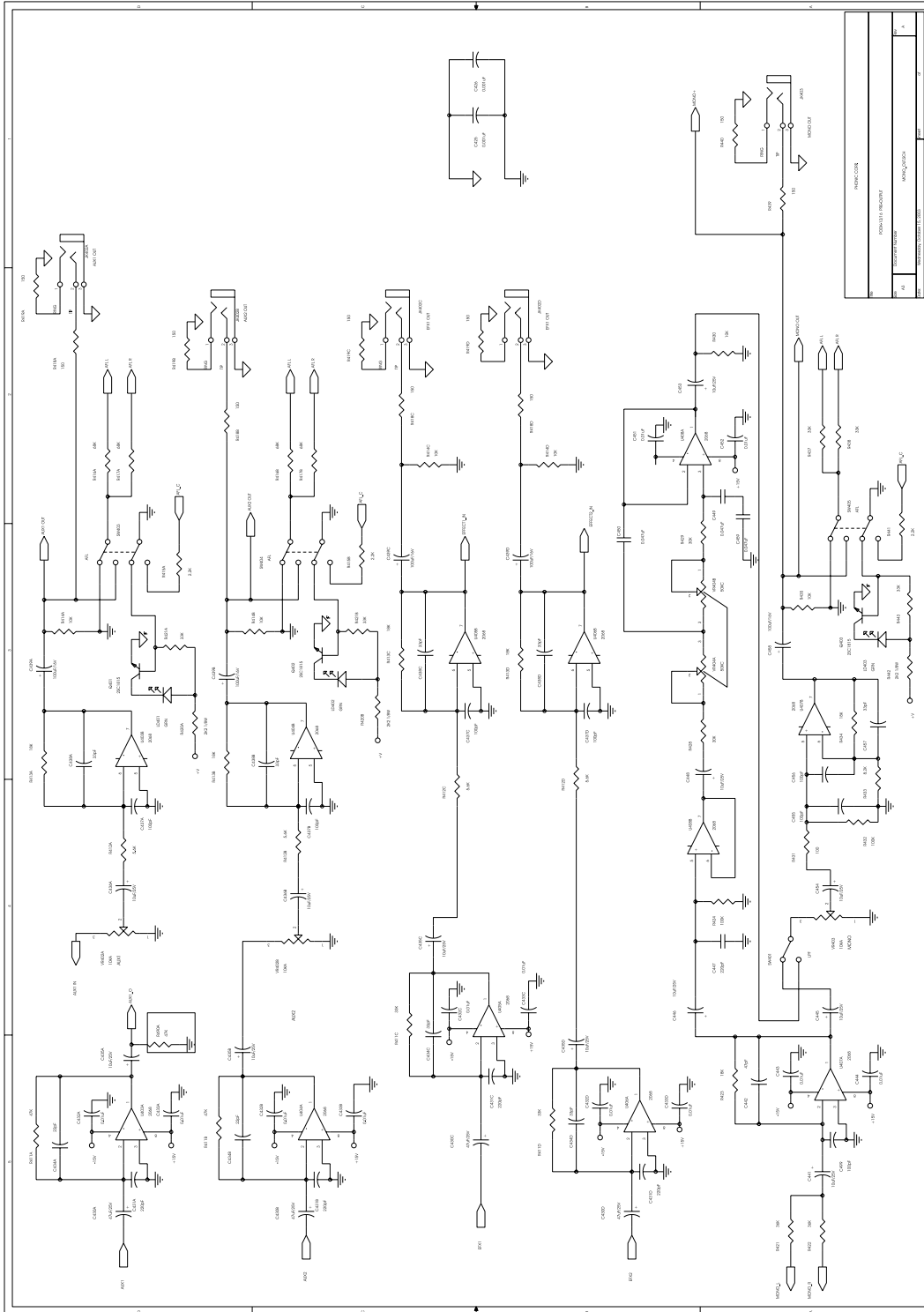

MAIN

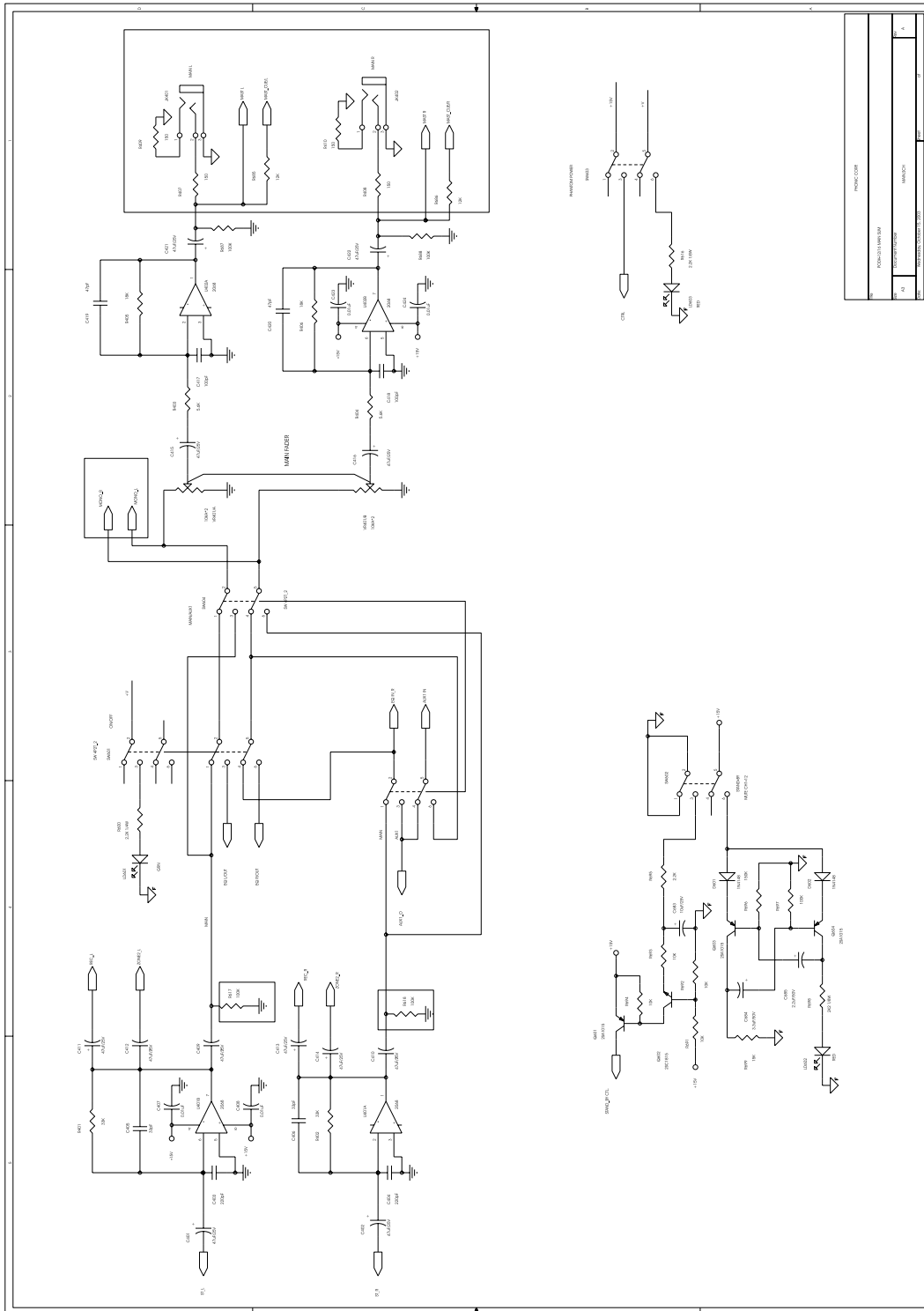

EFFECT

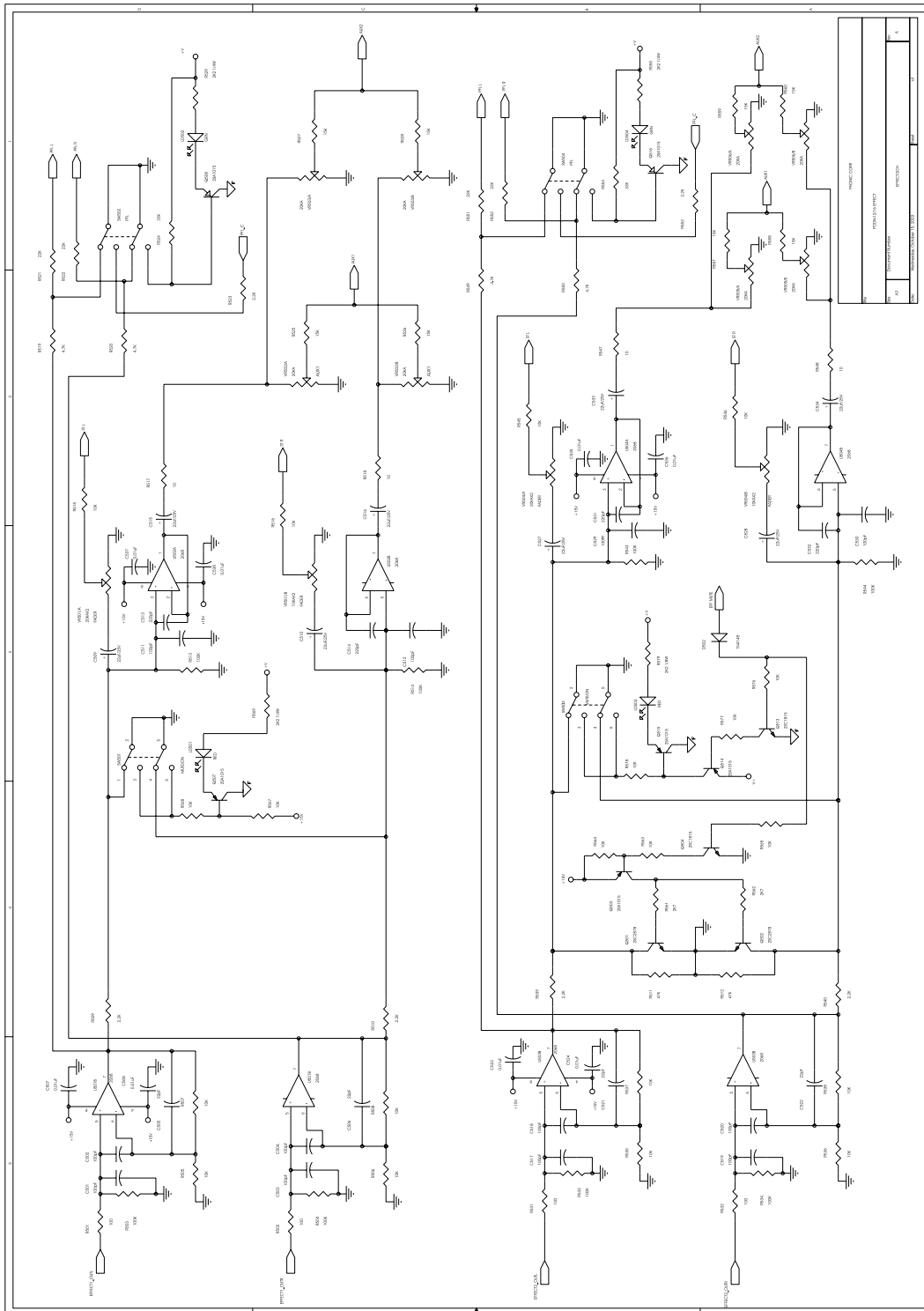

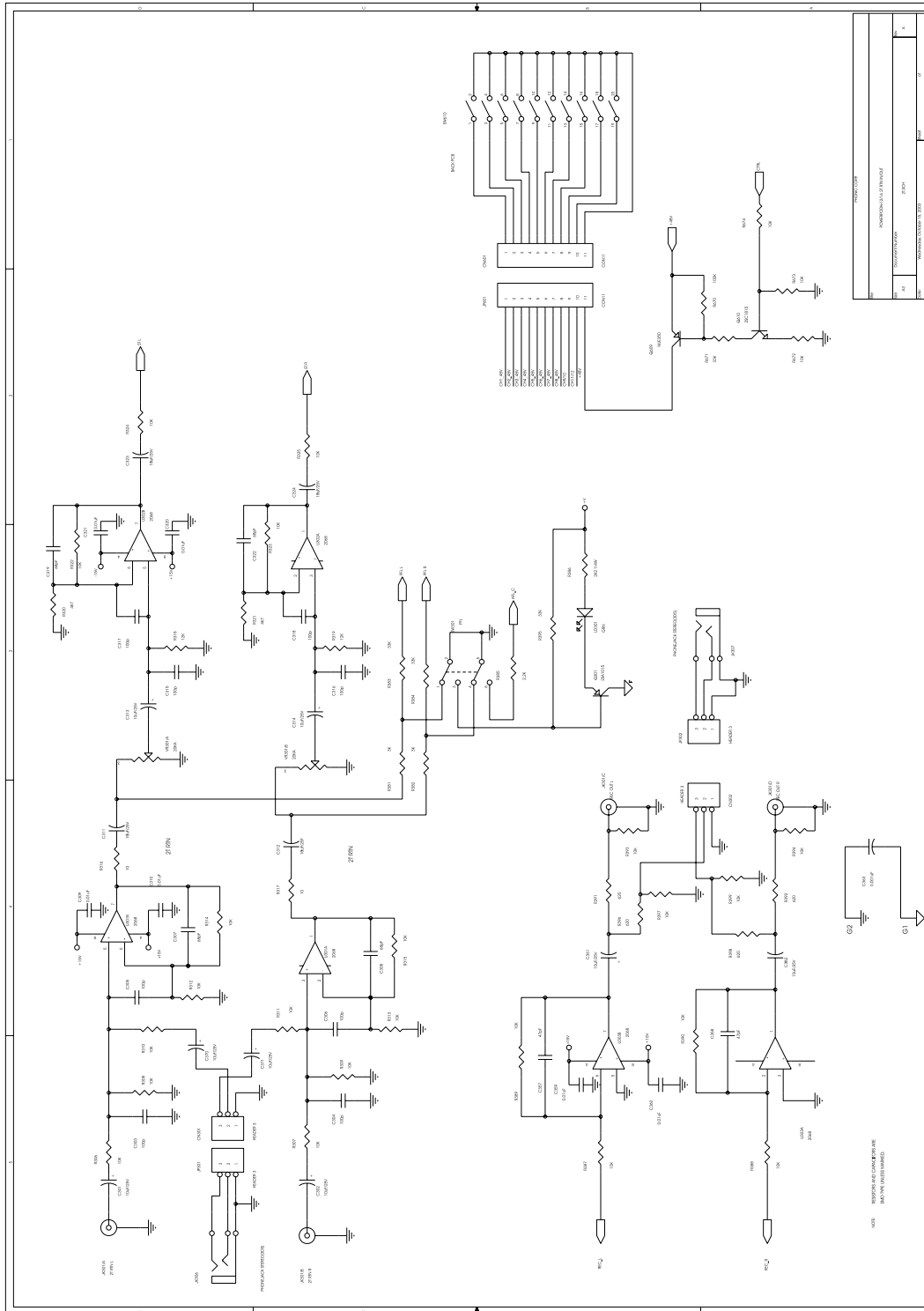

CH 1

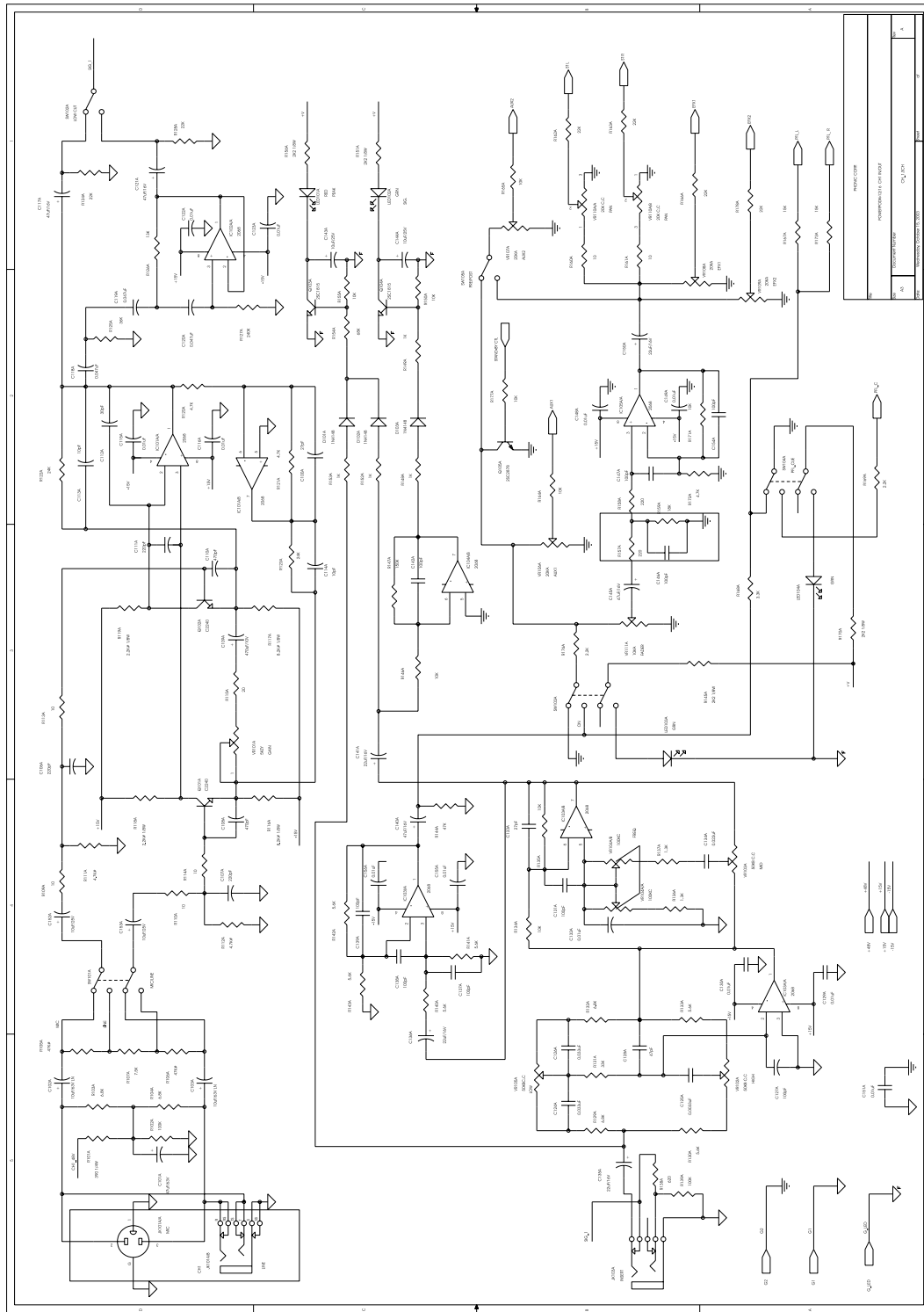

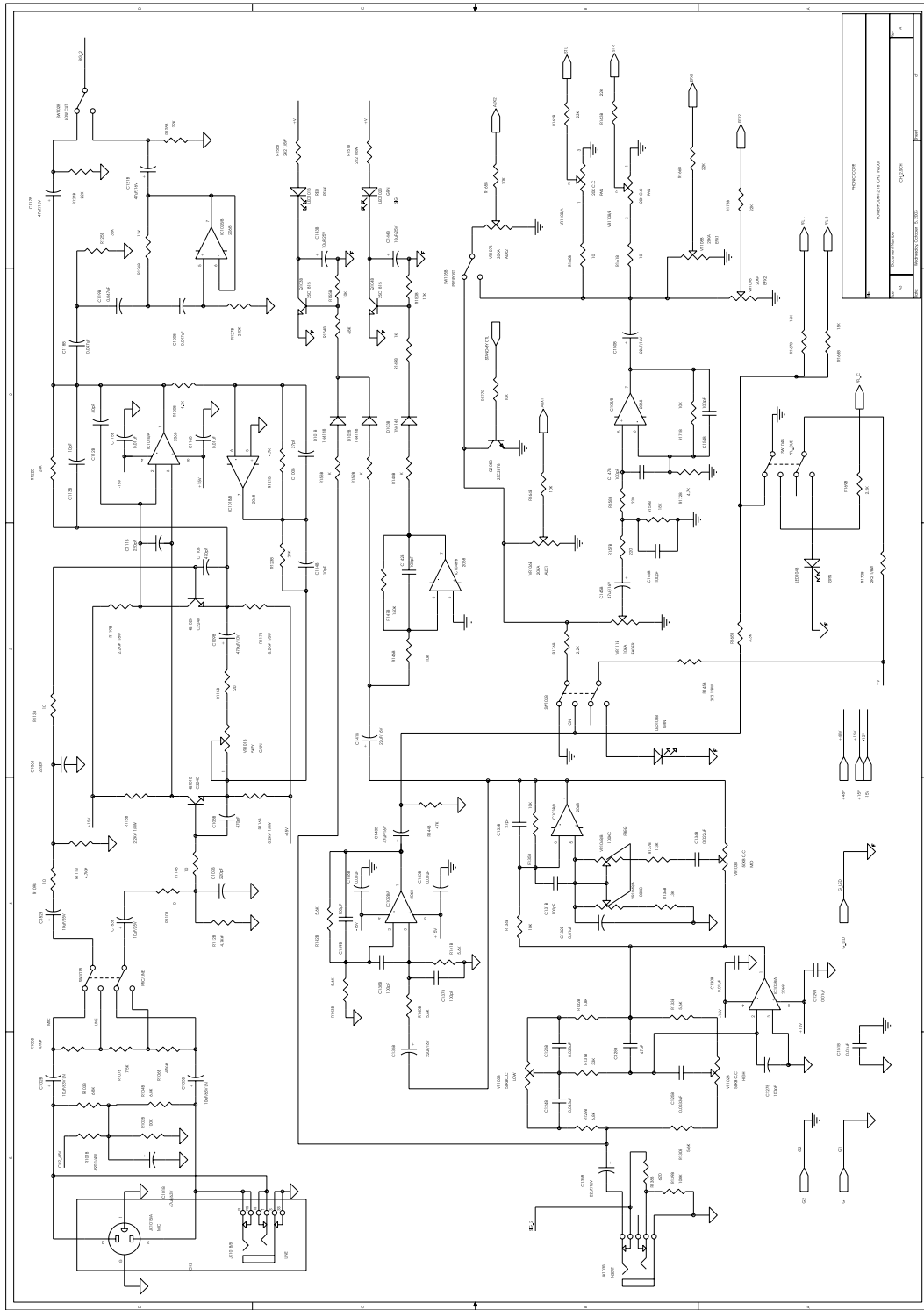

CH 3

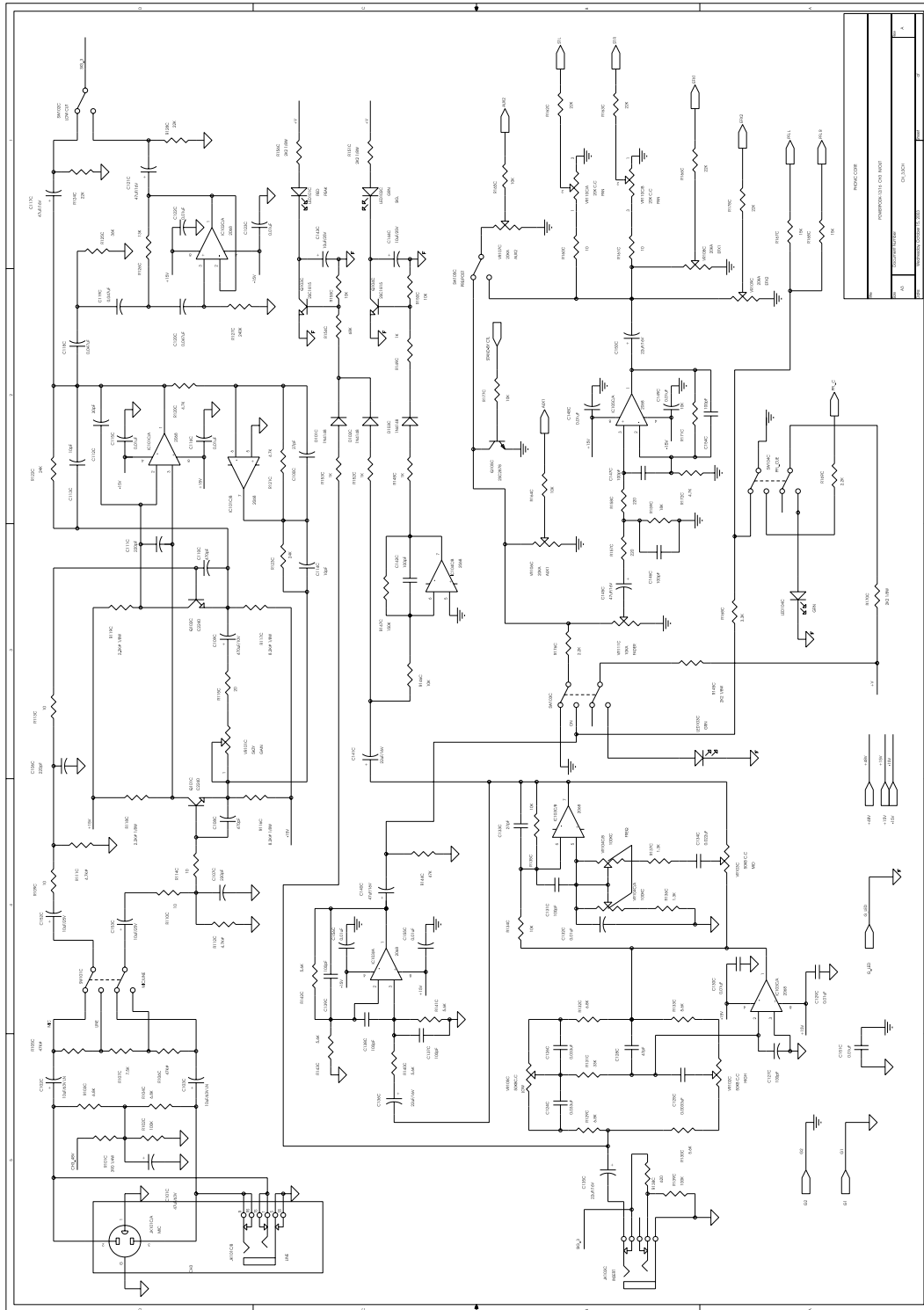

CH 5

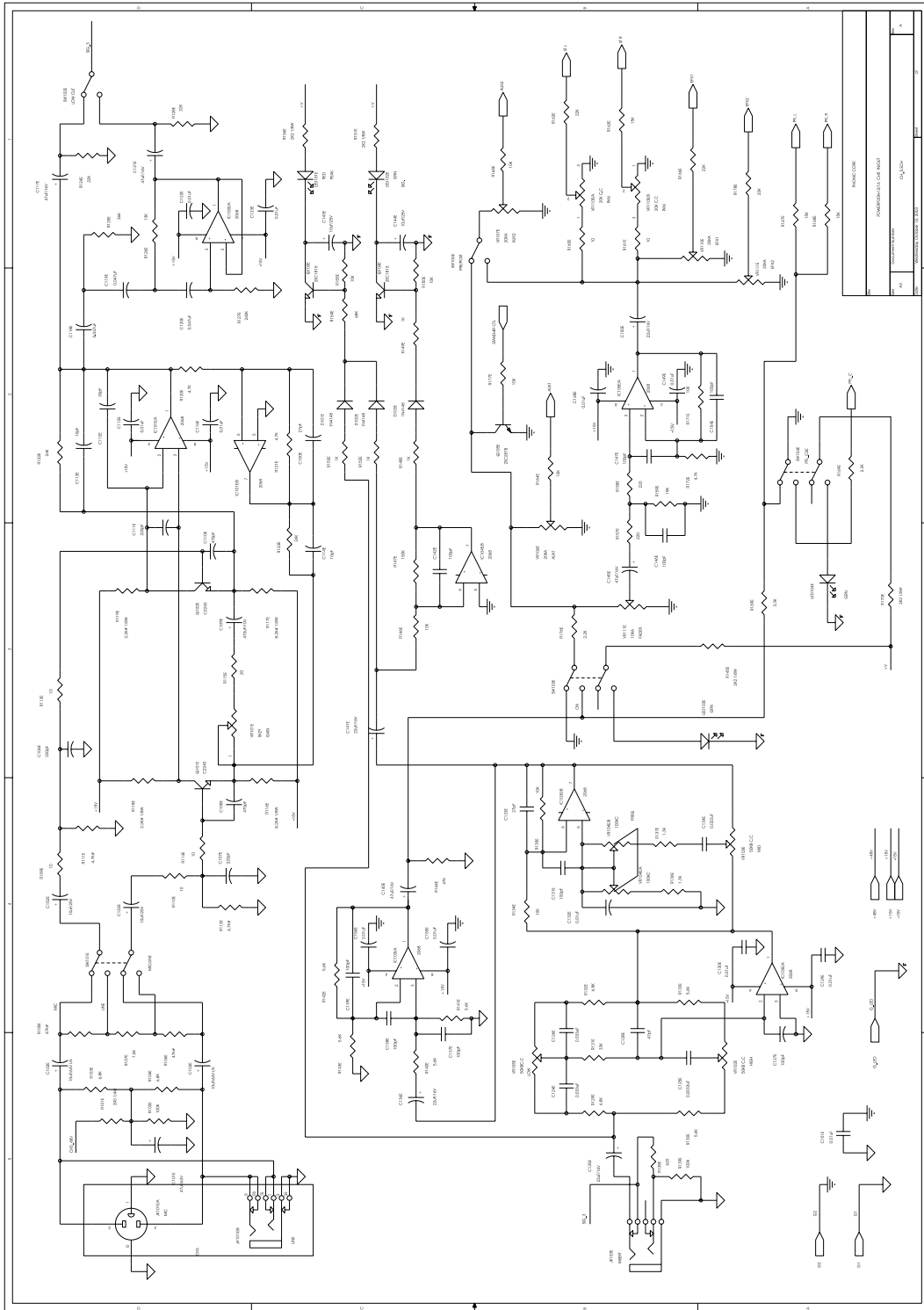

CH 8

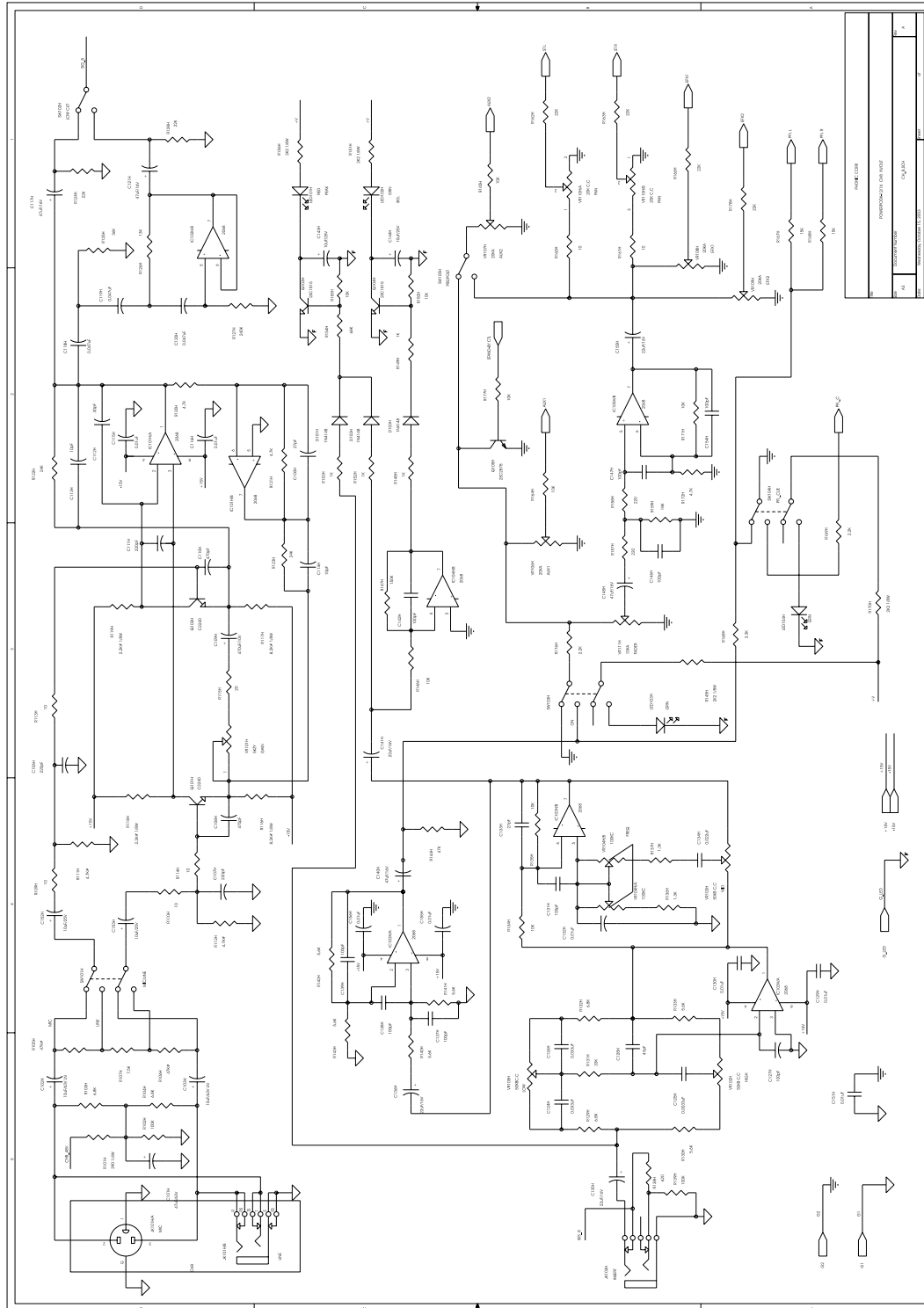

POWER REQUIREMENT CLASSIFICATION

Ref.	Phonic Part No.	Specifications
IEC		
T903	070-20909-500-0	X'MER IEC 230V PODK-12
FS901	280-1538B-000-0	FUSE 15A 250V UL/CSA/JIS S
FS902.903.904	280-2026B-000-0	FUSE 2A 250V UL/CSA/JIS S
FS905	280-80266-000-0	FUSE T8A/250V UL/CSA S
	370-15640-921-6	P/CORD 230V 10A 6T 3P
	573-61030-000-0	FUSE LABEL T8A H250V
UL		
T903	070-20902-100-0	X'MER PODK-12
FS901	280-1538B-000-0	FUSE 15A 250V UL/CSA/JIS S
FS902.903.904	280-2026B-000-0	FUSE 2A 250V UL/CSA/JIS S
	370-08610-721-0	P/CORD 120V15A6F3PSVT UL/CSA
SA		
T903	070-20909-500-0	X'MER IEC 230V PODK-12
FS901	280-1538B-000-0	FUSE 15A 250V UL/CSA/JIS S
FS902.903.904	280-2026B-000-0	FUSE 2A 250V UL/CSA/JIS S
FS905	280-80266-000-0	FUSE T8A/250V UL/CSA S
	370-06610-321-0	P/CORD 240V 15A 6F 3P SA
	573-61030-000-0	FUSE LABEL T8A H250V
SAA		
T903	070-20909-500-0	X'MER IEC 230V PODK-12
FS901	280-1538B-000-0	FUSE 15A 250V UL/CSA/JIS S
FS902.903.904	280-2026B-000-0	FUSE 2A 250V UL/CSA/JIS S
FS901	280-80266-000-0	FUSE T8A/250V UL/CSA S
	370-11610-821-0	P/CORD 240V 15A 6F 3P SAA
	573-61030-000-0	FUSE LABEL T8A H250V
JIS		
T903	070-20900-600-0	X'MER 100V JIS PODK12
FS901	280-1538B-000-0	FUSE 15A 250V UL/CSA/JIS S
FS902.903.904	280-2026B-000-0	FUSE 2A 250V UL/CSA/JIS S
	370-16610-629-0	P/CORD 100V 15A 6F 3P JIS
BS		
T903	070-20909-500-0	X'MER IEC 230V PODK-12
FS901	280-1538B-000-0	FUSE 15A 250V UL/CSA/JIS S
FS902.903.904	280-2026B-000-0	FUSE 2A 250V UL/CSA/JIS S
FS901	280-80266-000-0	FUSE T8A/250V UL/CSA S
	370-01610-921-0	P/CORD 240V 15A 6F 3P BS
	573-61030-000-0	FUSE LABEL T8A H250V

INPUT PCB

Ref.	Phonic Part No.	Specifications
R471.472	000-15106-400-0	CF RES.150J 1/8W T
R101A-101H.201A.201B	000-39126-400-0	CF RES. 390 J 0.25W T
R475.476	006-10070-440-0	MF RES. 10 F 1/8W T
R118A-118H.119A-	006-22010-440-0	MF RES 2K2 F 1/8W T
R116A-116H.117A-	006-82010-440-0	MF RES 8K2 F 1/8W T
R205A.205B.206A.206B.20 9A.209B.210A.210B.316.31 7.329.335.339.344.836.851	008-01002-600-0	CHIP RES. 10J SMT 0603 PKG
R308.309.389.390.397.3 99.473.474.483.484.672- 674.800-802.	008-01032-600-0	CHIP RES. 10K J 0603
R393.394.109A-109H.110A- 110H.RA3-8.23-25.27- 30.32-35.37-40.42-51.53-56	008-01032-600-1	
R102A-102H.105A- 105H.106A-106H.113A- 113H.114A-114H.139A- 139H.202A.202B.670	008-01042-600-0	CHIP RES. 100K J 0603
R108A-108H	008-01122-600-0	CHIP RES. 1.1K J 0603
R218A.218B.219A.219B	008-01232-600-0	CHIP RES. 12K J 0603
RRA26.31.36.41	008-01332-600-0	CHIP RES. 13K J 0603
R407-410.418A- 418D.419A- 419D.439.440.485-488	008-01512-600-0	CHIP RES. 150 J 0603
R852.855	008-01522-600-0	CHIP RES. 1.5K J 0603
R823A.858A	008-01532-600-0	CHIP RES. 15K J 0603
R306.307.832.847.RA1.2.3 10.311.314.315	008-01542-600-0	CHIP RES. 150K J 0603
R826.840	008-01832-600-0	CHIP RES. 18K J 0603
R115A-115H	008-02002-600-0	CHIP RES. 20 J 0603
R17.18	008-02022-600-0	CHIP RES. 2K J 0603
R821.837	008-02032-600-0	CHIP RES. 20K J 0603
R827-829.842-844	008-02042-600-0	CHIP RES. 200K J 0603
R328.333.338.343.391.392 .396.398	008-02212-600-0	CHIP RES. 220 J 0603
R833.848.853.856	008-02222-600-0	CHIP RES. 2.2K J 0603
R122A-122H.123A- 123H.180A- 180H.477.478.481.482	008-02232-600-0	CHIP RES. 22K J 0603
R465.466.469.470	008-02242-600-0	CHIP RES. 220K J 0603
R854.857	008-03022-600-0	CHIP RES. 3K J 0603
R327.332.337.342.374.376 .378.380	008-03032-600-0	CHIP RES 30K SMT J 0603 PKG
R227A.227B.228A.228B	008-03322-600-0	CHIP RES. 3.3K J 0603
R671	008-03332-600-0	CHIP RES. 33K J 0603

Ref.	Phonic Part No.	Specifications
R830.845	008-03342-600-0	CHIP RES. 330K J 0603
R387.388	008-03632-600-0	CHIP RES. 36K J 0603
R120A-120H.121A-121H.21 6A.216B.217A.217B.181A- 181H	008-04722-600-0	CHIP RES. 4.7K J 0603
RA52.57	008-04732-600-0	CHIP RES. 47K J 0603
RA9-12	008-05122-600-0	CHIP RES. 5.1K J 0603
R493.494	008-05612-600-0	CHIP RES. 560 J 0603
R822.838	008-05622-600-0	CHIP RES. 5.6K J 0603
R326.331.336.341.373.375 .377.379	008-05632-600-0	CHIP RES. 56K J 0603
R138A-138H	008-06212-600-0	CHIP RES. 620 J 0603
R831.846	008-06802-600-0	CHIP RES. 68 J 0603
R215A.215B.834.849	008-06812-600-0	CHIP RES. 680 J 0603
R103A-103H.104A-104H.2 25A.225B.226A.226B.203A .203B.204A.204B.479.480. 835.850	008-06822-600-0	CHIP RES. 6K8 J 0603
RA15.16	008-06822-600-1	
R467.468.RA13.14	008-06832-600-0	CHIP RES. 68K J 0603
R825.841	008-07522-600-0	CHIP RES. 7.5K J 0603
R312.313	008-07532-600-0	CHIP RES. 75K J 0603
R823.858	008-08222-600-0	CHIP RES. 8.2K J 0603
R824.839	008-09122-600-0	CHIP RES. 9.1K J 0603
R207A.207B.208A.208B	008-47012-400-0	CHIP RES. 4.7K F 0603
CDS1.2	010-00007-000-0	CDS 32SR2S SILONEX
VR101A-101H	022-50290-003-0	S.ROT/VR 5KZY L=30MM RD09F1130001- 5KZ
C109A-109H.208A.208B	030-10818-000-0	E/C 1000MF Z 10V D8*14 P
C802	032-47626-0A0-0	NP E/C 47MF M 16V 6*11 T
C801.	032-47626-0A0-0	NP E/C 47MF M 16V 6*11 T
C103A-103H.202B	033-10664-0A0-0	LN E/C 10MF J 63V T 6*11
C102A- 102H.202A.203A.203B	033-10664-0A0-0	LN E/C 10MF J 63V T 6*11
C152A-152H.153A-153H.22 3A.223B.224A.224B.301.30 2.311.312.331.332.341.342 .361.362	035-10635-0A0-0	MINI E/C 10MF K 25V T
C370.371.491.492.4105.4 106	035-10635-0A0-1	
C823	035-10726-0A0-0	MINI E/C 100MF M 16V T (4*7)
C499A.499B.4101.4102.41 13.4114.824	035-10726-0A0-0	MINI E/C 100MF M 16V T (4*7)
C135A-135H	035-22626-0A0-0	MINI E/C 22MF M 16V T

Ref.	Phonic Part No.	Specifications
C271A.271B.272A.272B .339.340.349.350.CA6- 10.13.14.805	035-47626-0A0-0	MINI E/C 47MF M 16V 5*7 T
C101A-101H.201A.201B C497.498	035-47665-0A0-0 039-10024-220-0	MINI E/C 47MF K 63V T CHIP C/C 10PF J 50V 0603
C225A.225B.226A.226B.22 7A.227B.228A.228B.4107- 4110.CA1-5.11.12	039-10124-220-0	CHIP C/C 100PF J 50V 0603
C100A-100H.112A- 112H.212A.212B C4103.4104	039-10124-220-1 039-10225-220-0	
C115A-115H.116A-116H.21 4A.214B.215A.215B.231A.2 31B.232A.232B.309.310.35 1-354.359	039-10325-220-0	CHIP C/C 0.001UF K 50V 0603 CHIP 0.01UF 50V K 0603 X7R
C360.4115.4116	039-10325-220-1	
C113A-113H.114A-114H.2 11A.211B.213A.213B.821 .822	039-22024-220-0	CHIP C/C 22PF J 50V 0603
C111A-111H.209A.209B.80 3.818.820	039-22124-220-0	CHIP C/C 220PF J 50V 0603
C303.304.307.308.337.338 .347.348	039-27024-220-0	CHIP C/C 27PF J 50V 0603
C493-496	039-33024-220-0	CHIP C/C 33PF J 50V 0603
C210A.210B.357.358.804	039-47024-220-0	CHIP C/C 47PF J 50V 0603
C106A-106H.107A- 107H.108A-108H.110A- 110H.204A-207A.204B- 207B	039-47124-220-0	CHIP C/C 470PF J 50V 0603
C817.819	039-51024-220-0	CHIP C/C 51P J 0603
C305.306.333-336.343- 346.4111.4112	039-68024-220-0	CHIP C/C 68PF J 50V 0603
DP2.4	090-01562-010-0	Z/DIODE 5V6 K 0.5W FAIRCH
D1-8	090-02000-020-0	DIODE 1N4148
Q1-4.610	120-00000-800-0	TRN 2SC1815 GR TO-92-D REEL(TO)
Q101A-101H.102A- Q609	120-00001-010-0 121-00006-100-0	TRN 2SC2240 TO-92-D REEL(TO) TRP MJE350 SOT-93-D (ON)
U411	160-00018-000-0	IC NJM4556AL JRC
U1.2	160-00022-710-0	IC NJM2058V SMD REEL(JRC)
IC101A-101H.U203A.20 3B.204A.204B.301.303- 305.412.801.UA1-3	160-00024-100-0	IC NJM4580M DMP (JRC) 2K SMD
SW402	210-01202-360-6	SLD/SW SS-22F20G8
SW801	210-01204-002-0	SLD/SW 2P4T
SW802	210-01403-010-0	SLD/SW 4P3T
SW101A-101H	210-02202-070-0	PUSH/SW SPEC12HC11-JP

Ref.	Phonic Part No.	Specifications
JK301	211-00041-100-0	4P RCA/J RL-1414-4D
JK103A-103H.202A.202B.2 03A.203B.302-305.610.611	211-01602-380-0	6D3/J (SCJ-0658-Y)
JK401.402.403.402A- 402D.405.406	211-01602-390-0	6D3/J JY-6351-02-030 SCJ-0658
JK404	211-01602-610-0	6D3/J
JK101A-101H	211-03300-030-6	COMBO CONNECTOR
JK200A.200B	211-03300-160-0	XLR/J SKCA229-1K3F2
CN301.302	211-10031-171-0	3P WAFER/S TJC3-3A PH=2.5MM
CN104	212-10030-050-0	3P WAFER/P 60MM UL1007#24 P=2.0
CN3	212-10041-240-0	4P WAFER/P 260MM
CN101A-101D	212-10080-040-0	8P WAFER/P 60mm UL1007#24 P=2.0
CN201	212-10111-001-0	11P WAFER/P 60MM UL1007#24 P=2.0
JP601	212-10111-010-0	11P WAFER/P 250mm UL1007#24 PH=2.5
CN101-103	212-10130-080-0	13P WAFER/P 60MM UL1007#24 P=2.0
JP4	212-10152-000-0	15P WAFER/P 720MM
	290-01660-101-0	PCB K-12 INPUT
SW402	610-00301-018-0	FIBER WAS. D3.0*8*1

REAT PCB

Ref.	Phonic Part No.	Specifications
R120N	000-10306-400-0	CF RES. 10K J 1/8W T
R123N.124N	000-22406-400-0	CF RES. 220K J 1/8W T
R122N	000-33206-400-0	CF RES. 3K3 J 1/8W T
R121N	000-47306-400-0	CF RES. 47K J 1/8W T
LC1-32	039-10324-220-0	CHIP C/C 0.01MF J 50V 0603
C77.83	042-10426-050-0	C/C2 0.1MF M 50V 5 T
LED4-35	100-01100-010-0	LED BAR LBD7113-03
U26	171-00000-310-0	MOS HD74HC74P DIP (TI/HI/PH)
U25	171-00003-500-0	MOS 74HC14 DIP (HT/TI/PH)
SW610	210-07100-000-0	DIP/SW 10PIN RS-10
JK306.307	211-01302-140-0	3D5/J SCJ-0345-X
JK1.2	211-01602-380-0	6D3/J (SCJ-0658-Y)
JKP03.04.06.07	211-01602-560-0	6D4/J YLJ-6405-300 (NUT&WASHER)
JKP05	211-03300-160-0	XLR/J SKCA229-1K3F2
JKP01.02	211-03400-021-0	SPEAKON/J SVP563S-CH
JP602	211-09161-010-0	16P B.E./S
JP3	211-10041-140-0	4P WAFER/S 2532-04
JP601	211-10111-090-0	11P WAFER/S
JP6	212-10021-060-6	2P WAFER/P 350MM UL1007#24 P=2.5MM
JP301.302	212-10032-520-0	3P WAFER/P UL1007#24 60MM PH=2.5MM
A1.A2.A3.A4	212-10044-001-0	4P WAFER/P UL1015#18 300MM
	290-01660-201-0	PCB K12 JACK

AMP PCB

Ref.	Phonic Part No.	Specifications
PR87.88	003-10071-602-0	CEMENT RES. 10 J 2W P
PR18.20.66.69	003-10093-602-0	CEMEN RE. 0.1 J 5W
PR34.34A.37.37A.40.40A. 48.48A.52.52A.54.54A	003-22093-603-0	CEMENT RES. 0.22R J 5W SOF-05
PR3.3A.4.4A.32.32A.46. 46A.	006-10002-440-0	MF RES. 100 F 0.25W T
PR31.31A.45.45A	006-10003-420-0	MF RES. 100F 0.5W M
PR79.83-85.89.94	006-10022-440-0	MF RES. 10K F 0.25W T
PR10.10A	006-10032-440-0	MF RES. 100K F 0.25W T
PR96.99	006-10072-440-0	MF RES 10 F 1/4W
PR97	006-10072-440-0	MF RES 10 F 1/4W
PR17.27.27A.56.56A.65	006-15002-420-0	MF RES. 150 F 0.25W M
PR1.1A	006-15012-440-0	MF RES 1K5 F 0.25W T
PR26.26A.42.42A.91	006-15022-440-0	MF RES. 15K F 0.25W T
PR81.82	006-15032-440-0	MF RES. 150K F 0.25W T
PR29.29A.43.43A.75.78	006-22002-440-0	MF RES. 220 F 0.25W T
PR15.64.80	006-22012-440-0	MF RES 2K2 F 0.25W T
PR2.2A.5.5A.90	006-22022-440-0	MF RES 22K F 0.25W T
PR14.35.35A.38.38A.41. 41A.49.49A.51.51A.55.5 5A.63	006-22072-440-0	MF RES. 22 F 0.25W T
PR16.19.22-24.67.68.70- 72.76.77	006-22082-440-0	MF RES. 2.2 F 0.25W T
PR95.95A	006-27012-440-0	MF RES. 2.7K F 0.25W T
PR7.7A.30.30A.44.44A.5 9.59A	006-33002-440-0	MF RES. 330 F 0.25W T
PR98	006-33012-440-0	MF RES. 3K3 F 0.25W T
PR33.33A.36.36A.39.39A. 47.47A.50.50A.53.53A	006-33072-440-0	MF RES. 33 F 0.25W T
PR11.11A.12.12A.60.60A .61.61A	006-47022-440-0	MF RES. 47K F 0.25W T
PR21.73.92.93	006-47082-440-0	MF RES. 4.7 F 0.25W T
PR6.6A.8.8A.28.28A.57.5 7A.58.58A	006-56002-420-0	MF RES. 560 F 0.25W M
PR13.62	006-56012-440-0	MF RES. 5K6 F 0.25W T
PR86	006-56022-440-6	MF RES. 56K +/-1% 0.25W T
PR25.74	006-68002-440-0	MF RES. 680 F 0.25W T
PTC1	011-22010-000-0	PTC PTMS2331RP416B16
PC28	030-10638-0A0-0	E/C 10MF Z 25V 5*11 T
PC14.14A.21.21A.26.34- 41	030-10668-0A0-0	E/C 10MF Z 63V 5*11 T
PC23.45	030-10798-0A0-0	E/C 100UF M 160V
PC46	030-10826-000-0	E/C 1000MF M 16V 10*18 P
PC6-8.6A.12.18.18A.25	030-225C5-0A0-0	E/C 2.2UF K 200V

Ref.	Phonic Part No.	Specifications
PC42-44	030-47586-200-0	E/C 4.7MF M 100V 5*11 P
PC29	030-47726-000-0	E/C 470MF M 16V 8*16 P
PC1.1A.27	032-47626-000-0	NP E/C 47MF M 16V 8*13 P
PC9.9A.19.19A	042-10085-000-0	C/C2 10PF K 500V
PC11.17.17A.20	042-101A6-050-0	C/C2 100PF M 250V 5 T
PC3.3A.4.4A	042-10225-050-0	C/C2 0.001MF K 50V 5 T
PC5.5A	042-10325-050-0	C/C2 0.01MF K 50V T
PC30-33	042-104A8-050-0	C/C2 0.1MF Z 250V 5
PC15.15A.16.16A	042-22225-050-0	C/C2 0.0022MF K 50V 5 T
PC13.24	042-222A5-050-0	C/C2 0.0022UF 250V K
PC2.2A	042-27085-000-0	C/C2 27PF K 500V 5
PC10.22	051-33515-000-0	M.P/C 3.3UF 100V K
PL2.5	072-20140-000-0	BEAD COIL 1.4UH
PL1.4	072-20141-000-0	BEAD COIL 100UH
PL7.8	075-10082-200-0	INDUCTANCE 1UH K M
PRY1.2	076-02422-010-0	RELAY OSA-SH-224DM3M
	090-00007-020-0	DIODE 1N4004 SILTEK T
PD14.22	090-00030-000-0	DIODE H16C40C MOSPEC
PDA2.2A	090-00031-000-0	DIODE HER103
PD13.13A.21.21A	090-00047-000-0	DIODE F08A20
PZD5-8	090-01223-000-0	Z/DIODE 22V 0.5W 1N5251B
PZD3	090-01273-010-0	ZEN/DIODE 27V K 0.5W
PZD4	090-01303-010-0	Z/DIODE 30V K 0.5W FAIRCH
PZD1.1A.2.2A	090-01562-010-0	Z/DIODE 5V6 K 0.5W FAIRCH
PZD9	090-01752-010-0	ZEN/DIODE 7V5 K 0.5W FAIRCH
PD1.1A.4-10.4A-10A.15.1 5A.17.17A.23.24.31	090-02000-020-0	DIODE 1N4148
PD3.3A.11.11A.19.19A.3 0.30A	090-02004-000-0	DIODE 1N4935 T
PQ4.4A.5.5A.40-42	120-00000-800-0	TRN 2SC1815 GR TO-92-D REEL(TO)
PQ3.3A.7.7A	120-00001-010-0	TRN 2SC2240 TO-92-D REEL(TO)
PQ13.14.16.17.21-23.21A- 23A.	120-00008-600-0	TRN 2SC5200-O DIP(TO) 100
PQ43	120-00009-500-0	TRN 2SC4793-M DIP(TO) 500
PQ11.19.19A.31.31A.32. 32A	120-00011-700-0	TRAN 2SC3468
PQ12.20.20A.30	120-00011-800-0	TRAN. 2SC4883A
PQ39	121-00000-200-0	TRP 2SA1015GR TO-92-D REEL(TO)
PQ1.1A.2.2A.6.6A.9.9A.38	121-00000-500-0	TRP 2SA970-BL TO-92-D REEL (TO)
PQ25-28.25A- 27A.29.35.36	121-00006-000-0	TRP 2SA1943-O DIP(TO) 100
PQ8.8A.10.10A.33.33A.37	121-00009-100-0	TRAN 2SA1371
PQ15.24.24A.34	121-00009-700-0	TRAN. 2SA1859A

Ref.	Phonic Part No.	Specifications
PU1	160-00001-219-0	IC 7812 DIP (ST) 400
PU4	160-00002-909-0	IC ST7915 TO-220-D(ST)
PU2.5	160-00004-114-0	IC 7805 DIP(ST) 400
PU3	160-00005-909-0	IC ST7815 TO-220-D(ST) DIP
PTC2	210-10085-010-0	TMP/SW US-602SXTFQL 85/75
CNN8.9.	211-10021-150-0	2P WAFER/S 5267 A2505 WV P=2.5MM
CNN4.6	211-10021-161-0	2P WAFER/S TJC3-2A P=2.5MM
CNN5	211-10044-040-0	4P WAFER/S A3963WV2-4P
CNN1	211-10064-000-0	6P WAFER/S 396106
CNN2	211-10101-080-0	10P WAFER/S 2532-10
CNN7	211-10151-090-0	15P WAFER/S 2532-15 P=2.5MM
T/SW	212-10023-440-0	2P WAFER/P 100MM
	290-01660-302-0	K-12 AMP PCB
PL1.4	290-61062-400-0	POD1062 DELUXE
	313-00000-000-0	TRANSISTOR WASHER TO-220
PV1-5	313-00000-090-0	IC WASHER 18*11.2
	313-00010-000-0	WASHER TO-3P
	314-00000-050-0	BUSHES 602S(V.0)
	526-20078-010-0	HEAT SINK 255*220*35MM
	526-60057-010-0	HEAT SINK(B) 15*10.7*40mm AL BLK
	552-60042-400-0	IC FIXED
	552-60043-400-0	IC FIXED
	590-43006-100-0	M/E PAN SCR. M3.0*6 NI
	590-43010-100-0	M/E PAN SCR. M3.0*10 NI
	590-43012-100-0	M/E PAN SCR. M3.0*12 NI
	591-43008-200-0	T/P PAN SCR. D3.0*8 BLK
	610-00300-501-0	PLA. WAS. D3.0*D7.0*0.5 NI
ALL	610-60301-006-0	SPR .WAS. D3*D5*1 NI
	615-20114-630-0	BOSS M3*(8+4)

POWER PCB

Ref.	Phonic Part No.	Specifications
R919.920	003-10093-602-0	CEMEN RE. 0.1 J 5W
R940	003-15073-602-0	CEMENT RES. 15 J 5W
R912.928	003-20023-602-0	CEMENT RES. 20K J 5W
R945	006-10002-440-0	MF RES. 100 F 0.25W T
R907	006-10012-440-0	MF RES. 1K F 0.25W T
R911	006-10012-440-0	MF RES. 1K F 0.25W T
R905.914.936.938.939	006-10022-440-0	MF RES. 10K F 0.25W T
R944	006-10032-440-0	MF RES. 100K F 0.25W T
R925	006-10042-440-0	MF RES 1M F 0.25W
R913.918.934	006-10082-440-0	MF RES. 1 F 0.25W T
R926	006-15074-440-0	MF RES. 15 F 1W T
R908.917.923	006-18022-440-0	MF RES. 18K F 0.25W T
R941	006-20012-420-0	MF RES. 2K F 0.25W T
R903	006-33012-440-0	MF RES. 3K3 F 0.25W T
R921	006-33022-440-0	MF RES. 33K F 0.25W T
R930.937	006-33023-420-0	MF RES.33K F 0.5W M
R906.910	006-33072-440-0	MF RES. 33 F 0.25W T
R904	006-33072-440-0	MF RES. 33 F 0.25W T
R942	006-39012-420-0	MF RES. 3K9 F 0.25W M
R922	006-39022-440-0	MF RES. 39K F 0.25W T
R901.902	006-39032-440-0	MF RES. 390K F 0.25W T
R915	006-47022-440-0	MF RES. 47K F 0.25W T
R909	006-51012-440-0	MF RES 5K1 F 0.25W T
R946.948	006-56012-440-0	MF RES. 5K6 F 0.25W T
R916.924	006-68012-440-0	MF RES. 6K8 F 0.25W T
R947	006-82002-440-0	MF RES. 820 F 0.25W T
PT903	011-22010-000-0	PTC PTMS2331RP416B16
PT901	011-22010-010-0	PTC PTMS2331RP730B34
PT902	011-22010-020-0	PTC PTLS2101RP816B
NTC901	012-10020-010-0	NTC THER. N20SP010L
C906.910.917	030-10638-0A0-0	E/C 10MF Z 25V 5*11 T
C942	030-10656-2A0-0	E/C 10MF M 50V 5*11T
C947	030-10736-0A0-0	E/C 100MF M 25V 8*11 T
C921	030-10846-000-0	E/C 1000MF M 35V 10*21 T
C913	030-22638-0A0-0	E/C 22MF Z 25V 5*11 T
C923.924.933.934	030-22798-200-0	E/C 220UF 160V Z 16*35H
C915.916.918.919	030-228C6-030-0	E/C 2200MF M 200V P
C927	030-47558-0A0-0	E/C 4.7MF Z 50V 5*11 T
C940.937	030-47586-200-0	E/C 4.7MF M 100V 5*11 P
C932.935.936.938.939	030-47758-001-0	E/C 470MF Z 50V 13*21 P
C946	042-222A5-050-0	C/C2 0.0022UF 250V K
C908	051-102C4-000-0	MP/C 0.001MF J 63V P

Ref.	Phonic Part No.	Specifications
C911	051-103C5-000-0	MP/C 0.01MF K 63V T(ESK063S10JA)
C907.909.912.914.944	051-104C5-000-0	MP/C 0.1MF K 63V T(ESK063P10JA)
C922	051-10545-000-0	MP/C 1MF K 400V PMM
C941.945	051-22435-000-0	MP/C 0.22UF K 250V
C920	051-224C5-000-0	MP/C 0.22MF K 63V T (ESK063P22JA)
C901.904.905.925.926	058-10226-000-0	LINE/C 0.001UF M 250V Y2
C902.903	058-22485-000-0	LINE/C 0.22MF K 275V P (FXK2A7P22K0)
C943	058-47236-001-0	LINE/C 0.0047MF M 400V
T904	070-2086B-800-0	X'MER 115/230V K-12
T901.902	072-20121-000-0	CHOCK COIL TF5104
L902.908	072-20124-000-0	CHOCK COIL 1111
L903.909	072-20137-000-0	CHOCK COIL 1118
L910-913	072-20138-000-0	BEAD COIL 1119
K901	076-02411-020-0	RELAY SDT-S-124DMR OEG
D901.906	090-00007-020-0	DIODE 1N4004 SILTEK T
D902	090-00026-000-0	DIODE HER107 (1A/800V)
D916	090-00030-000-0	DIODE H16C40C MOSPEC
D903.909.921.923-927.929.932	090-00031-000-0	DIODE HER103
D922	090-00032-000-0	DIODE H16C40A MOSPEC
D905.911	090-00037-000-0	DIODE HER308
D928	090-01123-000-0	ZEN/DIODE 12V J 0.5W UNIZON POD/XP/ MAX
D919.	090-01153-010-0	Z/DIODE 15V K 0.5W UNIZON
D931	090-01622-000-0	ZENER DIODE 6.2V J 0.5W T
D910.914.915	090-02000-020-0	DIODE 1N4148
D913	090-10017-000-0	B/DIODE KBJ2506
Q908.910.912.914	120-00000-800-0	TRN 2SC1815 GR TO-92-D REEL(TO)
Q901.904	120-00010-600-0	TRAN. 2SC2655Y TOSHIBA
Q913	120-00012-800-0	TRAN. 2SD2012 TOSHIBA
Q906.909	121-00000-200-0	TRP 2SA1015GR TO-92-D REEL(TO)
Q903.907	121-00008-400-0	TRAN. 2SA1020Y TOSHIBA
Q902.905	122-00002-700-0	MOSFET IRG4PC50W IR
U902	160-00005-909-0	IC ST7815 TO-220-D(ST) DIP
OC901	160-00010-501-0	IC 4N35 LI
U901	160-00026-400-0	IC IR2153D IR
SW901	210-02101-030-0	PSH/SW PA-03S-A1
J901	211-12300-070-0	AC/C SS-7B-1-A
JP901	212-10060-590-0	6P UL1015#16 260MM P=3.96MM
JP903	212-10100-390-0	10P UL1007#24 160MM P=2.54MM
FS901	281-00000-010-0	FUSE CLIP FH-1208
FS902.903.904.905	281-00000-020-0	FUSE CLIP FH-1206
	290-01660-500-0	PCB K12 POWER

Ref.	Phonic Part No.	Specifications
ZNR901	301-47100-000-0	ZNR 470V
Q913.916.922.PT901.903	313-00000-000-0	TRANSISTOR WASHER TO-220
Q902.905	313-00010-000-0	WASHER TO-3P
Q913.916.922	314-00000-050-0	BUSHES 602S(V.0)
	347-00000-230-0	FAN SP401012H
PT902	379-01500-101-0	M. WIRE UL 1007#26 50MM BLK
	526-20070-010-0	HEAT SINK 155*42.2*15 K12
	526-20071-010-0	HEAT SINK 105*42.2*15 K12
	552-60013-001-0	FAN FIXED SECC1.0
HEAT STNK	590-43006-100-0	M/E PAN SCR. M3.0*6 NI
HEAT SINK	590-43008-100-0	M/E PAN SCR. M3.0*8 NI
Q902.905	590-43010-100-0	M/E PAN SCR. M3.0*10 NI
	590-43014-100-0	M/E PAN SCR M3.0*14 NI
PT901.903.D913.916.922.	610-00300-501-0	PLA. WAS. D3.0*D7.0*0.5 NI
Q902.905.913		
ALL	610-60301-006-0	SPR .WAS. D3*D5*1 NI

DSP PCB

Ref.	Phonic Part No.	Specifications
R5.33.36.37.41.43.46-48.52.59.J3	008-00002-600-0	CHIP RES. 0 J 0603
R30.32	008-01002-600-0	CHIP RES. 10J SMT 0603 PKG
R8.11	008-01012-600-0	CHIP RES. 100 J 0603
R19-22	008-01022-600-0	CHIP RES. 1K J 0603
R25.27.58.65.66	008-01032-600-0	CHIP RES. 10K J 0603
R31.35	008-01072-600-0	CHIP RES. 1 J 0603
R50	008-02012-600-0	CHIP RES. 200 J 0603
R26.28	008-03312-600-0	CHIP RES. 330 J 0603
R29	008-03332-600-0	CHIP RES. 33K J 0603
R34	008-04702-600-0	CHIP RES. 47 J 0603
R9.10.14.15.16.17.67	008-04722-600-0	CHIP RES. 4.7K J 0603
R12.13	008-51002-400-0	CHIP RES. 510 F 0603
C3.9.13.15.20.22.25.28.30	039-10426-230-0	CHIP C/C 0.1MF M 50V 0603
C7.12.14.16-19	039-10526-900-0	CHIP E/C 1MF M 50V 4*5.4
C35.39	039-10606-900-0	CHIP E/C 10MF M 16V 4*5.4
C10.11	039-22024-200-0	CHIP C/C 22PF J 50V 0603
C8.21.23.24.26.27.29.31	039-47646-900-0	CHIP E/C 47MF M 6.3V 4*5.4
D2	090-00039-000-0	DIODE BAV99 SMD
Q1.2	120-00011-100-0	TRAN. MMBTA14 SOT-23 SMD
U5	160-00027-200-0	IC LD1117S33TR SOT-223-M REEL (ST/NS)
U10	160-00028-800-0	CODEC IC UDA1345TS SSOP28 SMD PHILIPS
U1	170-00007-000-0	TTL 74HC393 reel-M (PH) SMD
U8	171-00004-800-0	MOS 74HCT132 SO14-D reel-M (PH) SMD
U2	177-00003-900-0	DSP TMS57002 QFP-M TI SMD
U9	177-01002-320-0	MOM AT24C08AN SMD reel(ATM)
U3	177-01005-500-0	CPU TSB89C54X2 PLCC-M V.C(PH/SST)SMD
U3	177-01005-600-0	CPU TSB89C54X2 PLCC-M V.D(PH/SST)SMD
U6	177-01302-100-0	DRAM IC MIIB416256A 35T TSOP ESMT
J1	211-09202-000-0	20P B.E./S
	290-01660-401-0	K12 DSP REV-B
XT1	300-12004-010-0	CRYSTAL 12.000MHz SMD
L1.2.3	382-20010-010-0	TINNER WIRE 10MM D0.6

MISCELLANEOUS

Ref.	Phonic Part No.	Specifications
	035-10625-0A0-0	MINI E/C 10MF K 16V T
	315-00005-000-0	LUG 6D
	321-00000-007-0	CABLE TIE HW-100MM
	347-00000-320-0	FAN 80*80*15 DV12V
	510-60891-300-0	PANEL PODK-12
	510-60891-300-F	PANEL MATERIAL K12
	511-60461-300-0	BACK PANEL PODK-12
	511-60461-300-F	BACK PANEL MATERIAL K12
	512-20530-420-0	LF SIDE PANEL MATERIAL:ABS PANTONE: BLK
	512-20540-420-0	RT SIDE PANEL MATERIAL:ABS PANTONE: BLK
	516-60015-000-0	TOP COV. MATERIAL:ABS COLOR:BLK K12
	518-20190-300-0	BOT. COV. PODK-12 SECC 1.6
	518-20190-300-F	BOT. COV. MATERIAL K12
	524-20005-210-0	HANDLE POD1860 COLOR:BLACK
	525-00019-020-0	FEET D25*16 (FFT-3)
	525-20006-000-0	FEET D10.8*3 (R1003)
	527-05100-001-0	1 K-12 SECC 0.8 BLK
	527-05100-001-F	1 K12 MATERIAL
	527-05100-002-0	2 K-12 SECC 0.8
	527-05100-003-0	3 K-12 SECC 0.8
	529-20041-001-0	LED ACRYLIC LAENS PODK-12/K-16
PROGRAM	540-20460-220-0	R/KNOB 12 12.25*18 GREY BODY
GAIN*8	540-60170-120-0	R/KNOB 15 BLK (MR1843X)
	540-60300-120-0	R/KNOB
EFX*20.PARAMEFTER*2	540-60300-220-0	R/KNOB GREY BODY+BLUE CAP
GAIN*2, TAPE IN*1,LEVEL*2	540-60300-320-0	R/KNOB GREY BODY+WHT CAP
HF/MF/LF*38,PAN/BAL*10	540-60300-420-0	R/KNOB GREY BODY+CAP
AUX*28	540-60300-520-0	R/KNOB GREY BODY+BLK CAP
CH FADER*10	541-60005-020-0	S/KNOB SIZE 23*9.5 WHITE BODY+BLK POINT
MONO*1	541-60005-220-0	S/KNOB 432C BODY+WHT POINT SIZE: 23*9.5
L-R	541-60005-720-0	S/KNOB RED BODY+WHT POINT
DSP EFFECT*2	541-60005-820-0	S/KNOB BLUE BODY+WHT POINT
AUX1/2*2	541-60005-920-0	S/KNOB BLK BODY+WHT POINT
EQ ON*1, HF*10, MAIN L/R*1, PRE*10, TAPE IN PFL*1,ZONE AFL*1	542-20300-221-0	P/KNOB WHT BODY+COOL GREY 11C

Ref.	Phonic Part No.	Specifications
AFL*3,MIC/ LINE*8,ON*12,PFL*14,TAP DELAY*1	542-60090-222-0	P/KNOB WHT BODY+COOL GREY 11C
POWER SW	542-60280-020-0	P/KNOB BLK BODY+WHT TEXT
	543-60060-020-0	BUSHING ABS BLK K12
BACK PANEL	543-60080-020-0	P/KNOB PUSH BLK
	550-20035-600-0	CHASSIS (A) 428*359.5*0.5
	551-20053-420-0	POWERPOD1860
	551-20055-400-0	BRKT POWERPOD1860
	551-60087-400-0	LF BRKT. K12
	551-60087-400-F	LF BRKT K12 MATERIAL
	551-60088-400-0	RT BRKT K12
	551-60088-400-F	RT BRKT K12 MATERIAL
	551-60101-400-0	WIND BRKT PODK-12
	560-60132-200-0	CARTON PODK-12
	561-60114-300-0	G/B PODK-12
	562-60309-000-0	UP PULP PANEL K12
	562-60310-000-0	DOWN PULP PANEL K12
	566-10015-010-0	SPONGE 40*10*5
	566-60035-000-0	FOAMER 197.7*10*3mm
	566-60036-000-0	FOAMER 424*360
OWN. MANU.	568-00003-000-0	#10 240*340*0.05
	568-10064-000-0	PE BAG 850*650*0.05
POWER CORD	568-30011-000-0	PE BAG 300*110*0.05
	572-00000-050-0	DRYER 5g
	573-10124-010-0	GND LABEL MAR2
	573-60240-000-0	BAR CODE LABEL PHONIC
	573-60343-000-0	LABEL BLUE D=8mm
	573-60780-000-0	FUSE LABEL T2A L 250V
	573-61010-000-0	FUSE LABEL T15A H 250V
	574-01670-110-0	OWN. MANU. PODK-16/K-12/1860 DELUXE
2/3*6	590-02606-100-0	M/E FLT SCR. M2.6*6 NI
PANEL&CHASSIS*4	590-03006-200-0	M/E FLT SCR. M3.0*6 BLK
PANEL*28	590-03008-100-0	M/E FLT SCR. M3.0*8 NI
PANEL*5	590-03008-200-0	M/E FLT SCR. M3.0*8 BLK D=6
DSP PCB	590-43006-100-0	M/E PAN SCR. M3.0*6 NI
PCB&BOSS*14	590-43008-100-0	M/E PAN SCR. M3.0*8 NI
FOR FAN	590-43020-100-0	M/E PAN SCR. M3*20 NI
PHANTOM SW&BOSS*7	590-53006-100-0	M/E SET SCR. M3.0*6 NI
FAN BRKT*4,PANEL&BOT COV.*3,L/R BRKT*4	590-53006-200-0	M/E SET SCR. M3.0*6 BLK
	590-53008-200-0	M/E SET SCR. M3.0*8 D=6 BLK

Ref.	Phonic Part No.	Specifications
SPK. *4 POWER JACK*2	590-53010-100-0	M/E SET SCR. M3.0*10 NI
FIXED BOT COV&HANDLE*4	590-53010-200-0	M/E SET SCR. M3.0*10 BLK
	590-54006-200-0	M/E SET SCR. M4*6 BLK
FIXED XLR*4	591-03008-100-0	T/P FLT SCR. D3.0*8 NI
FIX RCA JACK*1	591-43008-100-0	T/P PAN SCR. M3*8 NI
FIXED BACK PANEL XLR*2	591-53008-100-0	T/P SET SCR. D3.0*8 NI
	591-54012-200-0	T/P SET SCR. D4.0*12 BLK
SPK.*4,POWER SOCK- ET*2 MAIN PCB*5,SW*2	600-00302-010-0	HEX. NUT M3.0*2.0 NI
GND	600-00602-010-0	HEX. NUT M6.0*2.0 NI
	610-00300-326-0	PE. WAS. D3.0*D6*0.3
FAN BRKT	610-00300-502-0	PLA. WAS. D3.0*D7.0*0.5 BLK
BOSS*14	610-00301-018-0	FIBER WAS. D3.0*8*1
JK03.04.06.07*3	610-20901-001-0	TOOTH WAS D9*12*1 NI
GND*1	610-30600-601-0	TOOTH WAS. D6.0*D11*0.6 NI
FOR SPK. JK	610-60300-701-0	PAN SPR WAS. D3.0*6*0.7 NI
FOR GND	615-10001-130-0	EARTH BOSS 2+5 NI
FOR GND	615-10002-130-0	EARTH BOSS 10+5 NI
DSP PCB*8	615-10032-630-0	BOSS 10*5.5
PCB&CHASSIS*2	615-20023-630-0	BOSS 15+5
PCB & TOP COVER*17	615-20088-620-0	SPACER SUPPORT H-16
PCB&CHASSIS*6	615-20114-630-0	BOSS M3*(8+4)
PAMTOME/SW*2	615-60044-630-0	BOSS L=6.0
	618-14180-662-0	SPEC FIXED PIN SR-2 WHT
	630-60068-450-0	PVC INSULATION 424*361*0.5t
	630-60069-410-0	MYLAR 255*10*1.0t
ALL 60MM S/VR*16	631-10002-000-0	HEMELON 80*12
ALL SW	631-10027-000-0	HEMELON 24*12
ALL LED	631-20029-000-0	HEMELON 10*10
ALL EQ VR*10	631-20032-000-0	HEMELON 36*10MM
METER LED	631-20033-000-0	HEMELON 85*22

PHONIC
www.phonic.com